

Window frame

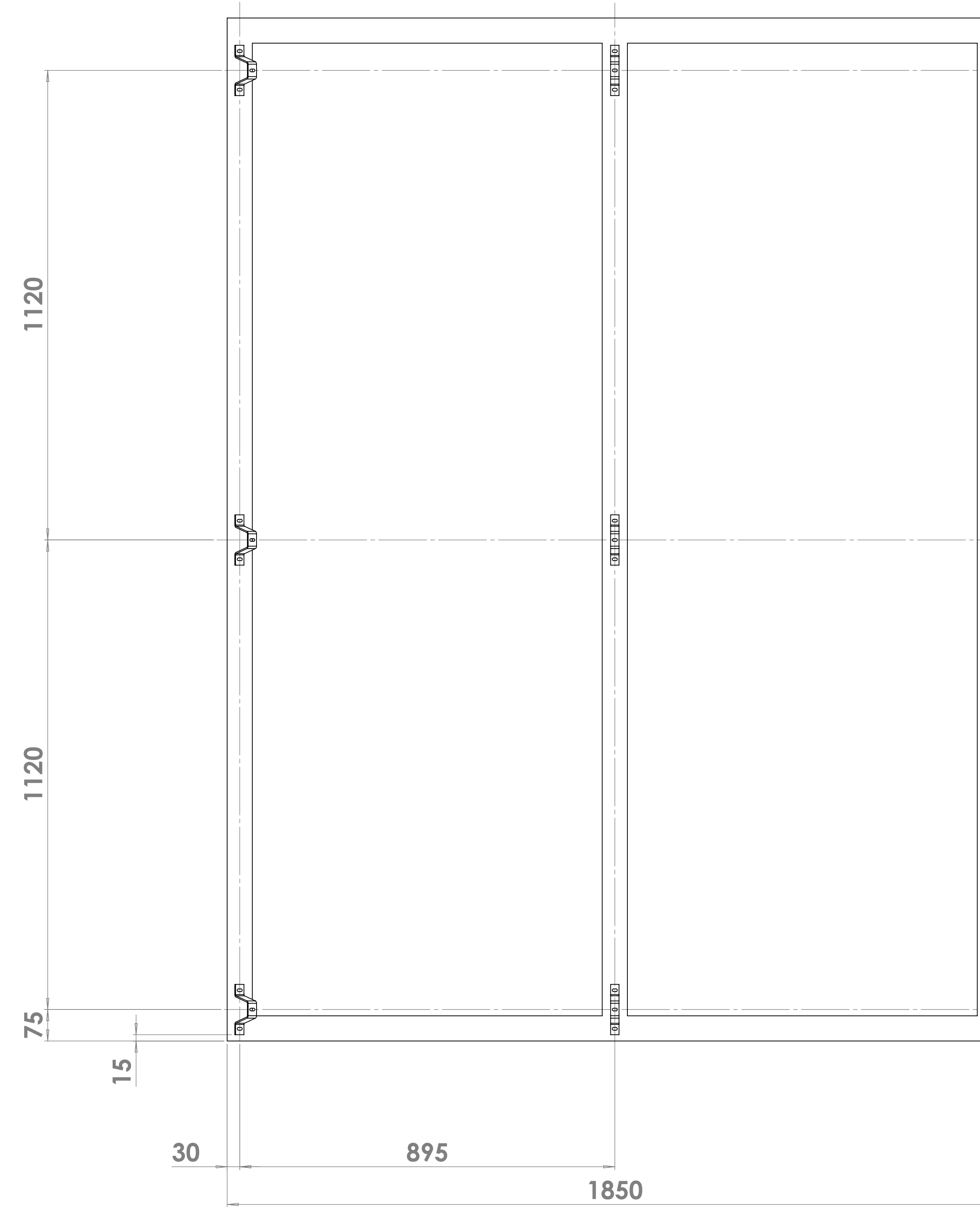

Window frame with brackets

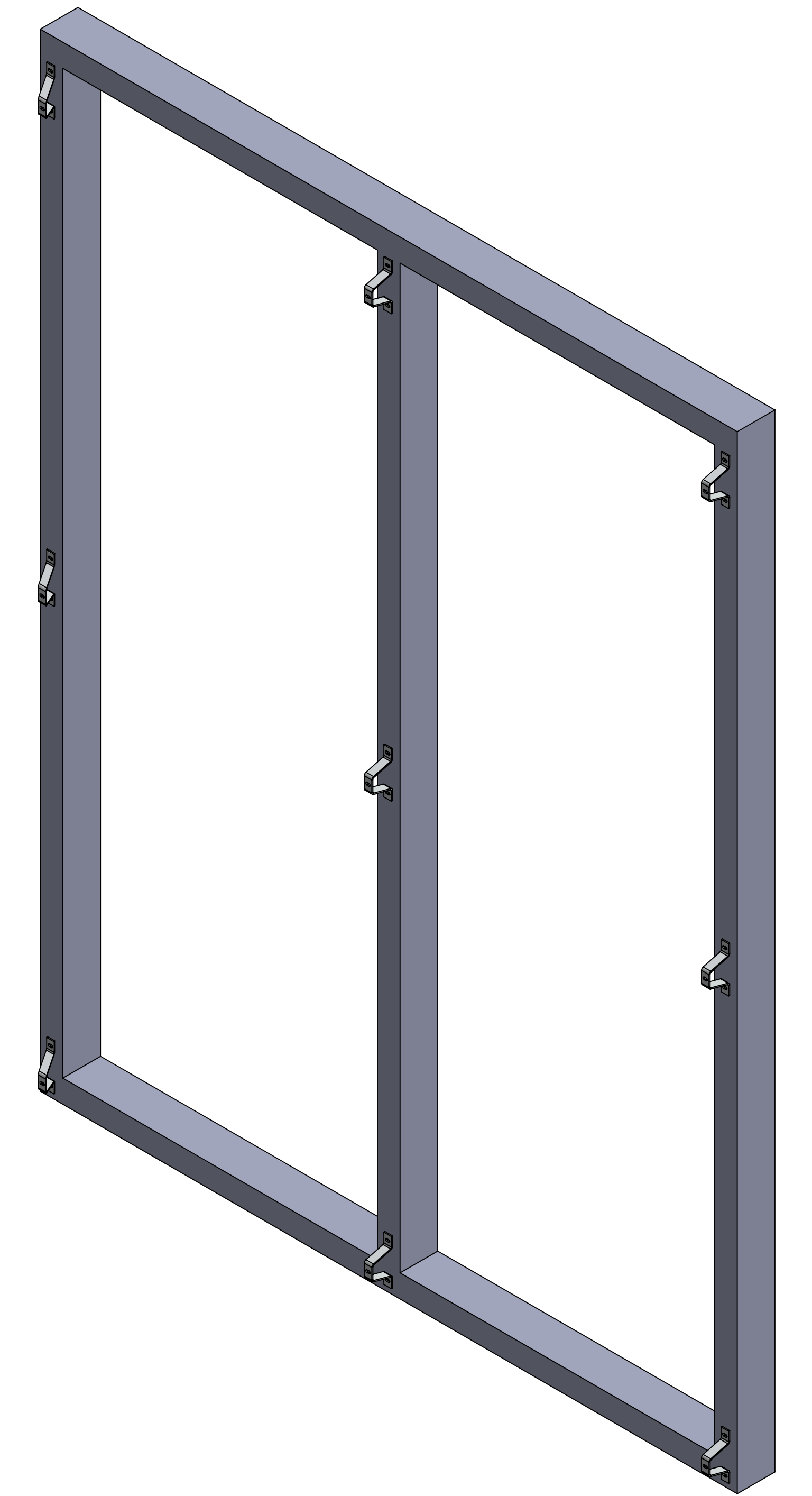
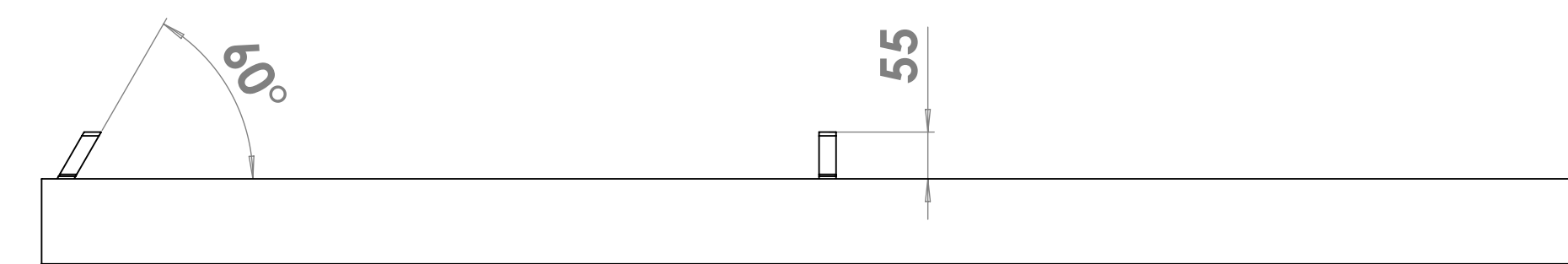

FASTENERS FOR INSTALLATION EXCLUDED (third party)				FASTENERS FOR SYSTEM ASSEMBLY INCLUDED			
CUSTOMER	DATE	5-8-2021	RACK ARMS & PARTS	RAL 9010 30%			
DESCRIPTION	SCALE	1:7.5	LOUVERS	RAL 9010 30%			
PROJECT NR	ENGINEER	JM	PLASTIC PARTS	White			
2107030							
2107030-03-000							
QTY	STATE	Under Editing	7SE	Ext	2107030-03-000	1:4	A0
REV	A						



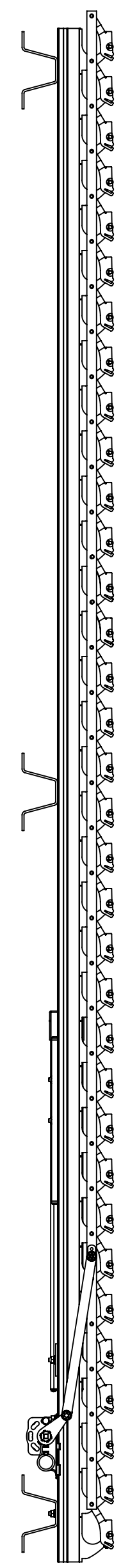

Closing Direction

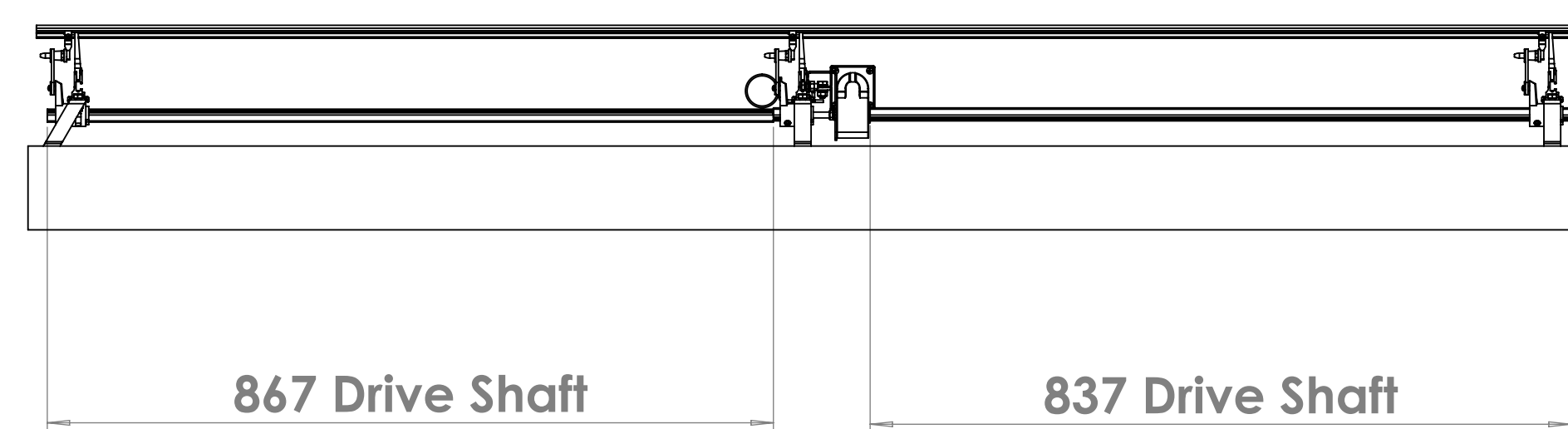
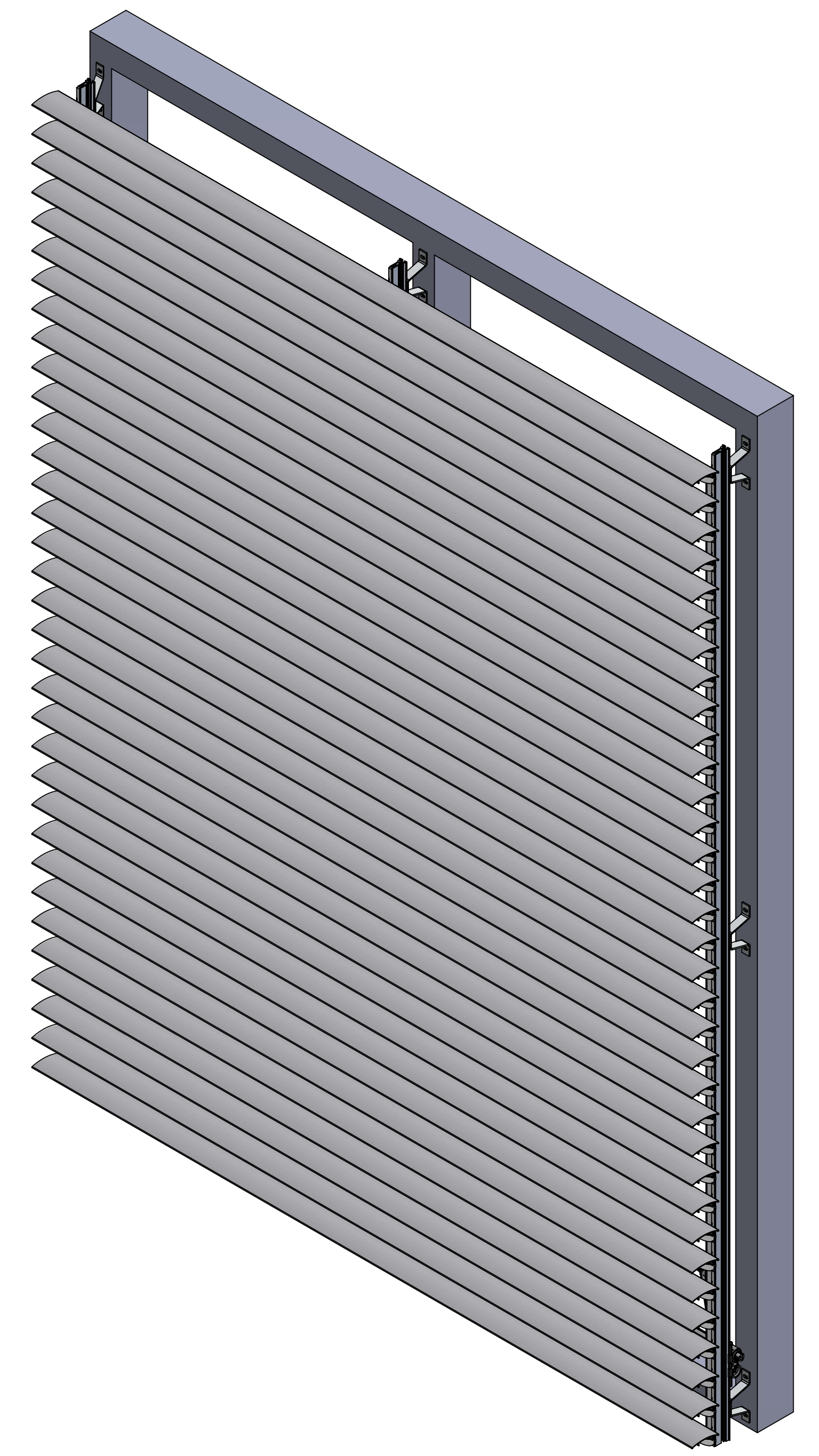
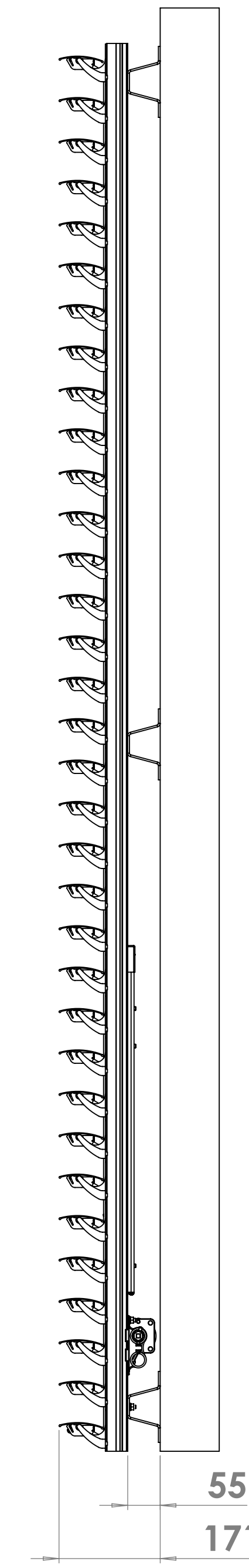
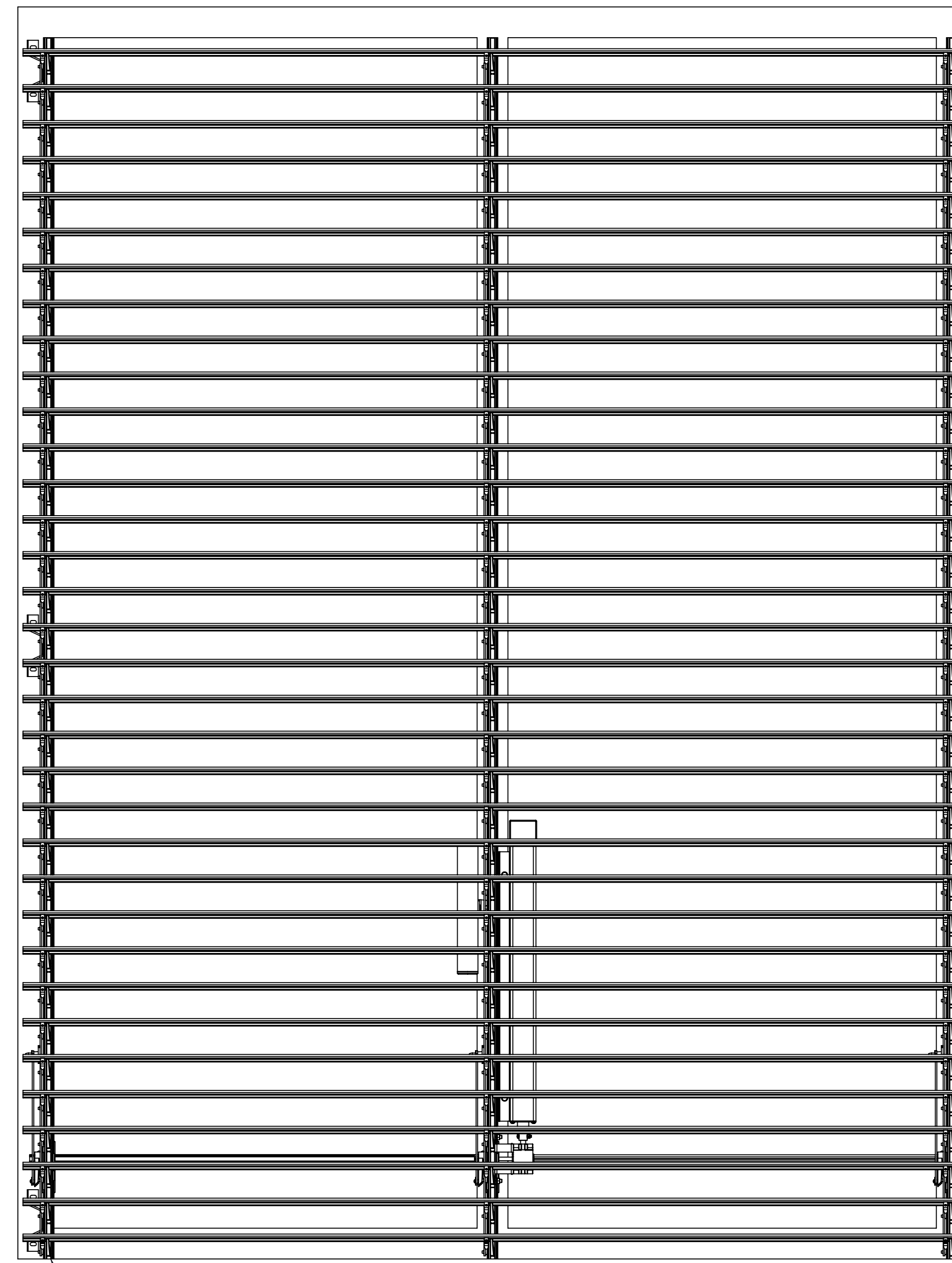
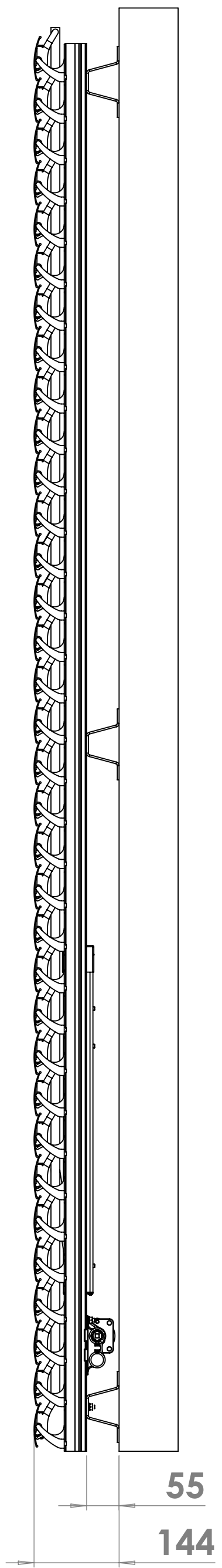

FASTENERS FOR INSTALLATION EXCLUDED (third party)				FASTENERS FOR SYSTEM ASSEMBLY INCLUDED			
MATERIAL							
CUSTOMER	DATE	5-8-2021	RACK ARMS & PARTS	RAL 9010 30%			
DESCRIPTION	SCALE	1:7.5	LOUVERS	RAL 9010 30%			
PROJECT NR	ENGINEER	JM	PLASTIC PARTS	White			
2107030							
Customer's ID	QTY	STATE	Under Editing	7SE	Ext	2107030-03-000	34 A0
HL 4941 V1	REV	A					
Project/Order/Order No.							
2107030							
Project/Order/Order No.							
2107030							
Project/Order/Order No.							
2107030							



